



Workshop Manual

electrical wiring

SUPPLEMENT

3000GT '98

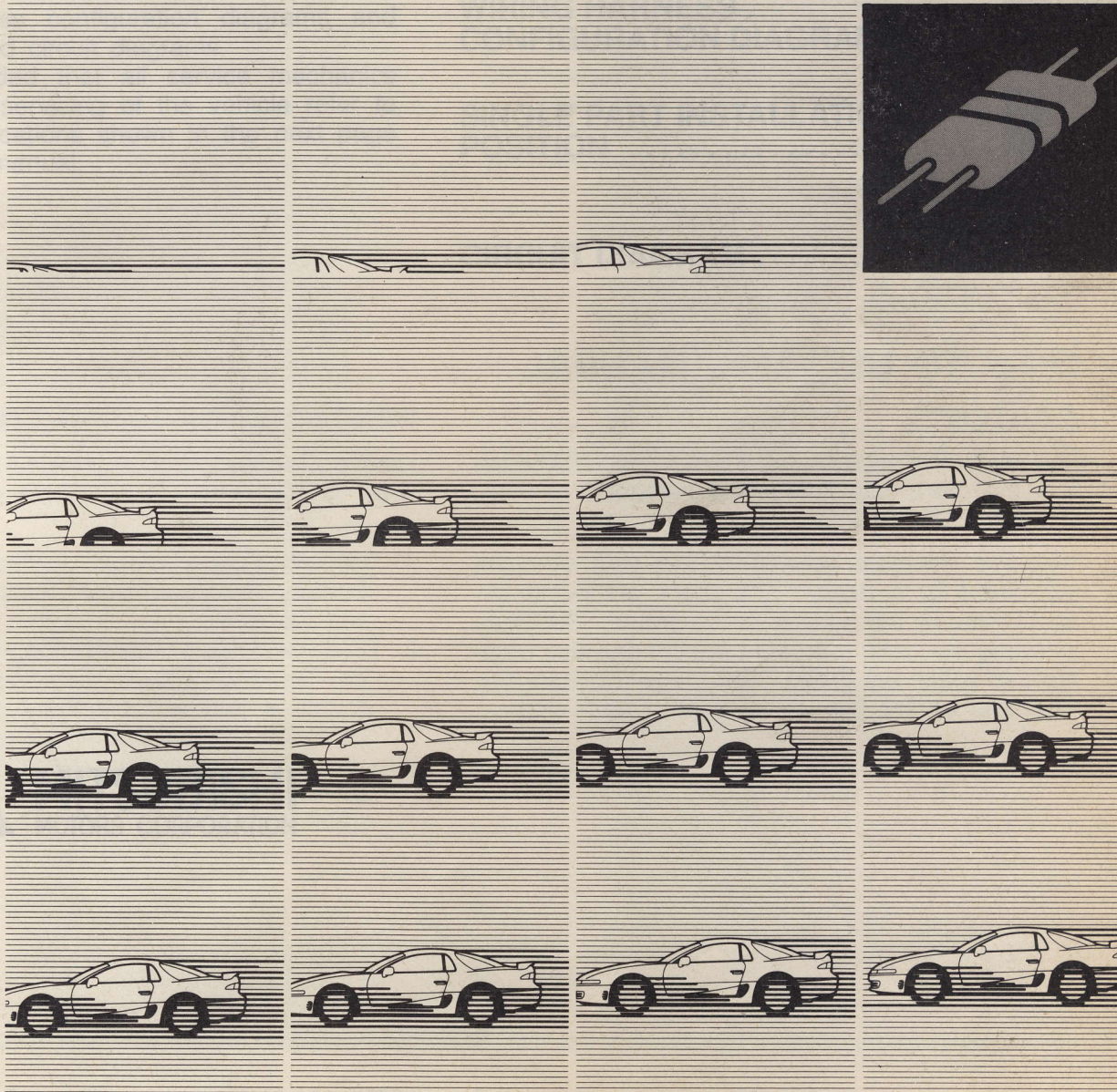
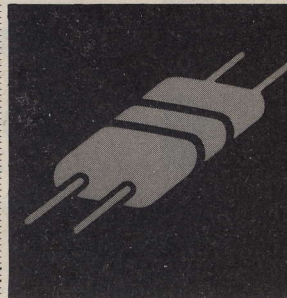

Pub. No. PHUE9201-F

Pub. No. PHUE9406-2

MITSUBISHI 3000GT

ELECTRICAL WIRING SUPPLEMENT

FOREWORD

This Electrical Wiring Manual contains information necessary for inspection and servicing of electrical wiring in the Mitsubishi 3000GT edited in the form of wiring harness configuration diagrams and function-separated circuit diagrams.

It is recommended that all service mechanics engaged in the servicing of the vehicle refer to the related publications shown in the next page as well as this manual.

GROUP INDEX

OUTLINE OF CHANGES

HOW TO READ THE WIRING DIAGRAMS

WIRING HARNESS CONFIGURATION DIAGRAMS

SINGLE PART INSTALLATION POSITION

CIRCUIT DIAGRAM

1

2

3

4



OUTLINE OF CHANGES

CONTENTS

WIRING HARNESS CONFIGURATION DIAGRAMS	2	CIRCUIT DIAGRAM	2
SINGLE PART INSTALLATION POSITION ...	2	TABLE OF CIRCUIT DIAGRAMS	3

System	Vehicle	Reference	Location of changes
CENTRALIZED JUNCTION	L.H. drive vehicles	4-2	Subtitle
	R.H. drive vehicles	4-8	
	L.H. drive vehicles for Europe	4-14	
	R.H. drive vehicles for Europe		
POWER DISTRIBUTION SYSTEM	L.H. drive vehicles		
	R.H. drive vehicles		
COOLING SYSTEM	L.H. drive vehicles		
	R.H. drive vehicles		
HEADLAMP	L.H. drive vehicles		
	R.H. drive vehicles		
	L.H. drive vehicles for Europe		
	R.H. drive vehicles for Europe		
HEADLAMP LEVELING SYSTEM	L.H. drive vehicles		
	R.H. drive vehicles		
TAIL LAMP, POSITION LAMP AND LICENCE PLATE LAMP	L.H. drive vehicles		
	R.H. drive vehicles		

WIRING HARNESS CONFIGURATION DIAGRAMS

Wiring harness configuration diagrams			Reference page	Description of changes
Connector symbol	Name			
C	DASH PANEL	L.H. drive vehicles	2-2	<ul style="list-style-type: none"> A/C-ECU connectors (C-97, C-98) have been added. The wiring layout for the air bag module (passenger's side) connector (C-85) has been changed. <R.H. drive vehicles>
		R.H. drive vehicles	2-4	

SINGLE PART INSTALLATION POSITION

Location of changes	Reference page	Description of changes
CONTROL UNIT	3-2	A/C-ECU connector has been added.

CIRCUIT DIAGRAM

Location of changes			Reference page	Description of changes
Main title	Subtitle			
AIR CONDITIONER	L.H. drive vehicles		4-2	The circuit has been changed to correspond to changes in the A/C-ECU.
	R.H. drive vehicles		4-8	
SUPPLEMENTAL RESTRAINT SYSTEM <SRS>	-		4-14	The colour of the wires for terminal Nos. 5 to 8 and terminal No. 14 of the SRS-ECU have been changed.

CONTENTS

The preceding page contains GROUP INDEX which lists the group title and group number.

PAGE NUMBERS

All page numbers consist of two sets of digits separated by a dash. The digits preceding the dash identify the number of the group. The digits following the dash represent the consecutive page number within the group. The page numbers can be found on the top left or right of each page.

INDICATION OF DESTINATION

Europe, General Export, Australia and New Zealand used for convenience to indicate destination.

NOTE

- "General Export" means territories other than Europe, Australia, New Zealand, the U.S.A. and Canada.
- "GCC" indicates a classification within the models for General Export category; models for countries that are members of the (Persian Gulf Cooperation) Council of nations.
- In some regions, vehicles with other specifications may be shipped to some countries.

TABLE OF CIRCUIT DIAGRAMS

This table of circuit diagrams indicates those circuits in which changes and/or additions, etc. have been made; the circuits are here listed in the sequence in which they are presented in the wiring diagrams. Please use this table for reference when following maintenance or repair procedures.

NOTE

- (1) A (Added) : This circuit has been newly added in this manual.
- (2) R (Revised) : This circuit has been changed, and is included in this manual.
- (3) D (Deleted) : This circuit has been deleted in this manual.
- (4) I (Included) : This circuit is included in this manual.
- (5) N (Not included) : This circuit is not included in this manual.
- (6) P (Previous manual) : This circuit is not included in this manual, because it has not been changed. Refer to the previous manuals.

Vehicles for Europe

Main circuit	Circuit classifications	Pub. No. PHUE9201-C (Loose-leaf)	Pub. No. PHUE9201-D (Supplement)	Pub. No. PHUE9201-E (Supplement)	Pub. No. PHUE9201-F (PHUE9406-2) (Supplement)
JUNCTION BLOCK	–	I	P	P	P
CENTRALIZED JUNCTION	–	I	R	P	P
POWER DISTRIBUTION SYSTEM	L.H. drive vehicles	I	P	P	P
	R.H. drive vehicles	I	P	P	P
STARTING SYSTEM	L.H. drive vehicles with theft-alarm system	I	P	P	P
	R.H. drive vehicles with theft-alarm system	I	P	P	P
	Vehicles without theft-alarm system	I	P	P	P
IGNITION SYSTEM	–	I	P	P	P
CHARGING SYSTEM	–	I	P	P	P
MPI SYSTEM	L.H. drive vehicles	I	D	N	N
	R.H. drive vehicles	I	D	N	N
	L.H. drive vehicles for Europe	N	A	R	P
	R.H. drive vehicles for Europe	N	A	R	P
COOLING SYSTEM	L.H. drive vehicles	I	P	P	P
	R.H. drive vehicles	I	P	P	P
HEADLAMP	L.H. drive vehicles with daytime running lamp	I	P	P	P
	L.H. drive vehicles without daytime running lamp	I	P	P	P
	R.H. drive vehicles with dim-dip lamp	I	P	P	P
	R.H. drive vehicles without dim-dip lamp	I	P	P	P
HEADLAMP LEVELING SYSTEM	–	I	P	P	P
TAIL LAMP, POSITION LAMP AND LICENCE PLATE LAMP	L.H. drive vehicles	I	P	P	P
	R.H. drive vehicles	I	P	P	P

Main circuit	Circuit classifications	Pub. No. PHUE9201-C (Loose-leaf)	Pub. No. PHUE9201-D (Supplement)	Pub. No. PHUE9201-E (Supplement)	Pub. No. PHUE9201-F (PHUE9406-2) (Supplement)
REAR FOG LAMP	L.H. drive vehicles with daytime running lamp	I	P	P	P
	L.H. drive vehicles without daytime running lamp	I	P	P	P
	R.H. drive vehicles	I	P	P	P
GLOVE BOX LAMP AND INSPECTION LAMP	—	I	P	P	P
ROOM LAMP, FOOT LAMP AND IGNITION KEY CYLINDER ILLUMINATION LAMP	L.H. drive vehicles	I	P	P	P
	R.H. drive vehicles	I	P	P	P
DOOR LAMP, LUGGAGE COMPARTMENT LAMP AND DOOR WARNING LAMP	L.H. drive vehicles	I	P	P	P
	R.H. drive vehicles	I	P	P	P
TURN-SIGNAL LAMP AND HAZARD LAMP	L.H. drive vehicles	I	P	P	P
	R.H. drive vehicles	I	P	P	P
STOP LAMP	L.H. drive vehicles	I	P	P	P
	R.H. drive vehicles	I	P	P	P
BACK-UP LAMP	L.H. drive vehicles	I	P	P	P
	R.H. drive vehicles	I	P	P	P
HORN	Vehicles with theft-alarm system	I	P	P	P
	Vehicles without theft-alarm system	I	P	P	P
METER AND GAUGE	—	I	P	P	P
4WS FLUID LEVEL WARNING LAMP	—	I	P	P	P
BRAKE WARNING LAMP	—	I	P	P	P
LOW FUEL WARNING LAMP	—	I	P	P	P
OIL PRESSURE WARNING LAMP	—	I	P	P	P
LOW ENGINE OIL LEVEL WARNING LAMP	—	I	P	P	P
POWER WINDOW	—	I	P	P	P
CENTRAL DOOR LOCKING SYSTEM	—	I	P	P	P
AIR CONDITIONER	L.H. drive vehicles	I	D	N	R
	R.H. drive vehicles	I	D	N	R
	L.H. drive vehicles for Europe	N	A	P	N
	R.H. drive vehicles for Europe	N	A	P	N
WINDSHIELD WIPER AND WASHER	—	I	P	P	P
REAR WIPER AND WASHER	L.H. drive vehicles	I	P	P	P
	R.H. drive vehicles	I	P	P	P

Main circuit	Circuit classifications	Pub. No. PHUE9201-C (Loose-leaf)	Pub. No. PHUE9201-D (Supplement)	Pub. No. PHUE9201-E (Supplement)	Pub. No. PHUE9201-F (PHUE9406-2) (Supplement)
HEADLAMP WASHER	–	I	P	P	P
REMOTE CONTROLLED MIRROR	L.H. drive vehicles	I	P	P	P
	R.H. drive vehicles	I	P	P	P
DEFOGGER	–	I	P	P	P
RADIO AND TAPE PLAYER	L.H. drive vehicles	I	P	P	P
	R.H. drive vehicles	I	P	P	P
SUNROOF	–	N	A	P	P
CLOCK	–	I	P	P	P
CIGARETTE LIGHTER	–	I	P	P	P
ANTI-LOCK BRAKE SYSTEM	L.H. drive vehicles	I	P	R	P
	R.H. drive vehicles	I	P	R	P
ELECTRONIC CONTROL SUSPENSION	L.H. drive vehicles	I	P	P	P
	R.H. drive vehicles	I	P	P	P
ACTIVE AERO SYSTEM	L.H. drive vehicles with theft-alarm system	I	P	P	P
	L.H. drive vehicles without theft-alarm system	I	P	P	P
	R.H. drive vehicles with theft-alarm system	I	P	P	P
	R.H. drive vehicles without theft-alarm system	I	P	P	P
SUPPLEMENTAL RESTRAINT SYSTEM <SRS>	L.H. drive vehicles	I	P	D	N
	R.H. drive vehicles	I	P	D	N
	–	N	N	A	R
AUTO-CRUISE CONTROL SYSTEM	L.H. drive vehicles	I	P	P	P
	R.H. drive vehicles	I	P	P	P
POWER SEAT	L.H. drive vehicles	I	P	P	P
	R.H. drive vehicles	I	P	P	P
THEFT-ALARM SYSTEM	L.H. drive vehicles	I	P	P	P
	R.H. drive vehicles	I	P	P	P
IMMOBILIZER SYSTEM	–	N	A	P	P

Vehicles for General Export, GCC and Australia

Main circuit	Circuit classifications	Pub. No. PHUE9406 (Basic)	Pub. No. PHUE9406-1 (Supplement)	Pub. No. PHUE9201-F (PHUE9406-2) (Supplement)
JUNCTION BLOCK	–	I	P	P
CENTRALIZED JUNCTION	–	I	P	P
POWER DISTRIBUTION SYSTEM	L.H. drive vehicles	I	P	P
	R.H. drive vehicles	I	P	P
STARTING SYSTEM	L.H. drive vehicles with theft-alarm system	I	P	P
	R.H. drive vehicles with theft-alarm system	I	P	P
	Vehicles without theft-alarm system	I	P	P
IGNITION SYSTEM	–	I	P	P
CHARGING SYSTEM	–	I	P	P
MPI SYSTEM	L.H. drive vehicles	I	P	P
	R.H. drive vehicles for General Export with catalytic converter	I	P	P
	R.H. drive vehicles for General Export without catalytic converter	I	P	P
	Vehicles for Australia	I	R	P
COOLING SYSTEM	L.H. drive vehicles	I	P	P
	R.H. drive vehicles	I	P	P
HEADLAMP	L.H. drive vehicles	I	P	P
	R.H. drive vehicles	I	P	P
TAIL LAMP, POSITION LAMP AND LICENCE PLATE LAMP	L.H. drive vehicles	I	P	P
	R.H. drive vehicles for General Export	I	P	P
	Vehicles for Australia	I	P	P
FOG LAMP	L.H. drive vehicles	I	P	P
	R.H. drive vehicles for General Export	I	P	P
GLOVE BOX LAMP, VAINITY MIRROR LAMP AND INSPECTION LAMP	Vehicles for General Export and GCC	I	P	P
	Vehicles for Australia	I	P	P
ROOM LAMP, FOOT LAMP AND IGNITION KEY CYLINDER ILLUMINATION LAMP	L.H. drive vehicles	I	P	P
	R.H. drive vehicles	I	P	P
DOOR LAMP, LUGGAGE COMPARTMENT LAMP AND DOOR WARNING LAMP	L.H. drive vehicles	I	P	P
	R.H. drive vehicles	I	P	P
TURN-SIGNAL LAMP AND HAZARD LAMP	L.H. drive vehicles	I	P	P
	R.H. drive vehicles for General Export	I	P	P
	Vehicles for Australia	I	P	P

Main circuit	Circuit classifications	Pub. No. PHUE9406 (Basic)	Pub. No. PHUE9406-1 (Supplement)	Pub. No. PHUE9201-F (PHUE9406-2) (Supplement)
STOP LAMP	L.H. drive vehicles	I	P	P
	R.H. drive vehicles for General Export	I	P	P
	Vehicles for Australia	I	P	P
BACK-UP LAMP	L.H. drive vehicles	I	P	P
	R.H. drive vehicles	I	P	P
HORN	Vehicles with theft-alarm system	I	P	P
	Vehicles without theft-alarm system	I	P	P
METER AND GAUGE	Vehicles for General Export and GCC	P	P	P
	Vehicles for Australia	P	P	P
4WS FLUID LEVEL WARNING LAMP	-	P	P	P
BRAKE WARNING LAMP	Vehicles for General Export and GCC	P	P	P
	Vehicles for Australia	P	P	P
LOW FUEL WARNING LAMP	-	P	P	P
OIL PRESSURE WARNING LAMP	-	P	P	P
POWER WINDOW	-	P	P	P
CENTRAL DOOR LOCKING SYSTEM	-	P	P	P
AIR CONDITIONER	L.H. drive vehicles	P	P	R
	R.H. drive vehicles	P	P	R
	Vehicles for Australia	N	A	N
WINDSHIELD WIPER AND WASHER	-	P	P	P
REAR WIPER AND WASHER	L.H. drive vehicles	P	P	P
	R.H. drive vehicles	P	P	P
REMOTE CONTROLLED MIRROR	L.H. drive vehicles	P	P	P
	R.H. drive vehicles	P	P	P
DEFOGGER	-	P	P	P
RADIO AND TAPE PLAYER	L.H. drive vehicles	P	P	P
	R.H. drive vehicles	P	P	P
CLOCK	-	P	P	P
CIGARETTE LIGHTER	-	P	P	P
ANTI-LOCK BRAKE SYSTEM <ABS>	L.H. drive vehicles	P	P	P
	R.H. drive vehicles	P	P	P
ELECTRONIC CONTROL SUSPENSION	L.H. drive vehicles	P	P	P
	R.H. drive vehicles	P	P	P

Main circuit	Circuit classifications	Pub. No. PHUE9406 (Basic)	Pub. No. PHUE9406-1 (Supplement)	Pub. No. PHUE9201-F (PHUE9406-2) (Supplement)
ACTIVE AERO SYSTEM	Vehicles with theft-alarm system	P	P	P
	Vehicles without theft-alarm system	P	P	P
SUPPLEMENTAL RESTRAINT SYSTEM <SRS>	L.H. drive vehicles	P	P	N
	R.H. drive vehicles	P	P	N
	-	N	N	A
AUTO-CRUISE CONTROL SYSTEM	L.H. drive vehicles	P	P	P
	R.H. drive vehicles	P	P	P
POWER SEAT	L.H. drive vehicles	P	P	P
	R.H. drive vehicles	P	P	P
TENSION-REDUCER TYPE SEAT BELT	L.H. drive vehicles	P	P	P
	R.H. drive vehicles	P	P	P
THEFT-ALARM SYSTEM	L.H. drive vehicles	P	P	P
	R.H. drive vehicles	P	P	P
IGNITION KEY REMINDER BUZZER	Vehicles for GCC	P	P	P
IMMOBILIZER SYSTEM	-	N	A	P

HOW TO READ THE WIRING DIAGRAMS

CONTENTS

MODELS	1-2
---------------------	------------

MODELS**Vehicles for Europe**

Model code	Engine model	Transmission model	Fuel supply system
Z16AMJGFL6	6G72 (2,972ml)	W6MG1	MPI
Z16AMJGFR6			

Vehicles for General Export

Model code	Engine model	Transmission model	Fuel supply system
Z16AMNGFL	6G72 (2,972ml)	W5MG1	MPI
Z16AMNGFR			

Vehicles for GCC

Model code	Engine model	Transmission model	Fuel supply system
Z16AMNGFLW	6G72 (2,972ml)	W5MG1	MPI

Vehicles for Australia

Model code	Engine model	Transmission model	Fuel supply system
Z16AMNGFR8	6G72 (2,972ml)	W5MG1	MPI

WIRING HARNESS CONFIGURATION DIAGRAMS

CONTENTS

DASH PANEL **C**

L.H. drive vehicles	2-2
R.H. drive vehicles	2-4

C-45	Engine control unit	C-17	Power transistor (for A/C circuit) (103-2A)
C-44	Engine control unit	C-16	Air-fuel sensor
C-43	Engine oil level relay	C-15	Headlamp washer relay
C-42	Headlamp washer relay	C-14	Lighting monitor buzzer
C-41	Lighting monitor buzzer	C-13	Lighting monitor buzzer
C-40	Lighting monitor buzzer	C-12	Lighting monitor buzzer
C-39	Lighting monitor buzzer	C-11	Lighting monitor buzzer
C-38	Lighting monitor buzzer	C-10	Lighting monitor buzzer
C-37	Lighting monitor buzzer	C-09	Lighting monitor buzzer
C-36	Lighting monitor buzzer	C-08	Lighting monitor buzzer
C-35	Lighting monitor buzzer	C-07	Lighting monitor buzzer
C-34	Lighting monitor buzzer	C-06	Lighting monitor buzzer
C-33	Lighting monitor buzzer	C-05	Lighting monitor buzzer
C-32	Lighting monitor buzzer	C-04	Lighting monitor buzzer
C-31	Lighting monitor buzzer	C-03	Lighting monitor buzzer
C-30	Lighting monitor buzzer	C-02	Lighting monitor buzzer
C-29	Lighting monitor buzzer	C-01	Lighting monitor buzzer
C-28	Lighting monitor buzzer		
C-27	Lighting monitor buzzer		
C-26	Lighting monitor buzzer		
C-25	Lighting monitor buzzer		
C-24	Lighting monitor buzzer		
C-23	Lighting monitor buzzer		
C-22	Lighting monitor buzzer		
C-21	Lighting monitor buzzer		
C-20	Lighting monitor buzzer		
C-19	Lighting monitor buzzer		
C-18	Lighting monitor buzzer		
C-17	Lighting monitor buzzer		
C-16	Lighting monitor buzzer		
C-15	Lighting monitor buzzer		
C-14	Lighting monitor buzzer		
C-13	Lighting monitor buzzer		
C-12	Lighting monitor buzzer		
C-11	Lighting monitor buzzer		
C-10	Lighting monitor buzzer		
C-09	Lighting monitor buzzer		
C-08	Lighting monitor buzzer		
C-07	Lighting monitor buzzer		
C-06	Lighting monitor buzzer		
C-05	Lighting monitor buzzer		
C-04	Lighting monitor buzzer		
C-03	Lighting monitor buzzer		
C-02	Lighting monitor buzzer		
C-01	Lighting monitor buzzer		

DASH PANEL

L.H. drive vehicles

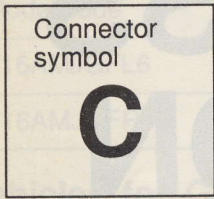

JUNCTION BLOCK (Front side)

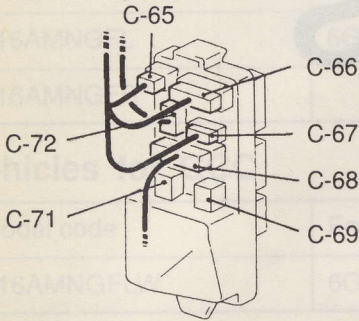

(Rear side)

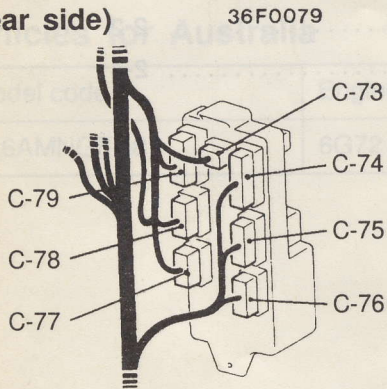

36F0079

36F0139

- C-01 } Body wiring harness (main) and front wiring harness combination
- C-02 }
- C-03 }
- C-04X Door lock power relay
- C-05X Rear fog lamp relay
- C-06X Defogger relay
- C-07X Power window relay
- C-08 -
- C-09 } Column switch
- C-10 }
- C-11 -
- C-12 Control wiring harness and instrument panel wiring harness combination
- C-13 Body wiring harness (main) and instrument panel wiring harness combination
- C-14 Blend air damper control motor
- C-15 Mode selection damper control motor
- C-16 } -
- C-17 }
- C-18 Power transistor (for A/C circuit)
- C-19 Air-inlet sensor
- C-20 Air selection damper control motor
- C-21 } Body wiring harness (main) and control wiring harness combination
- C-22 }

Refer to CENTRALIZED JUNCTION

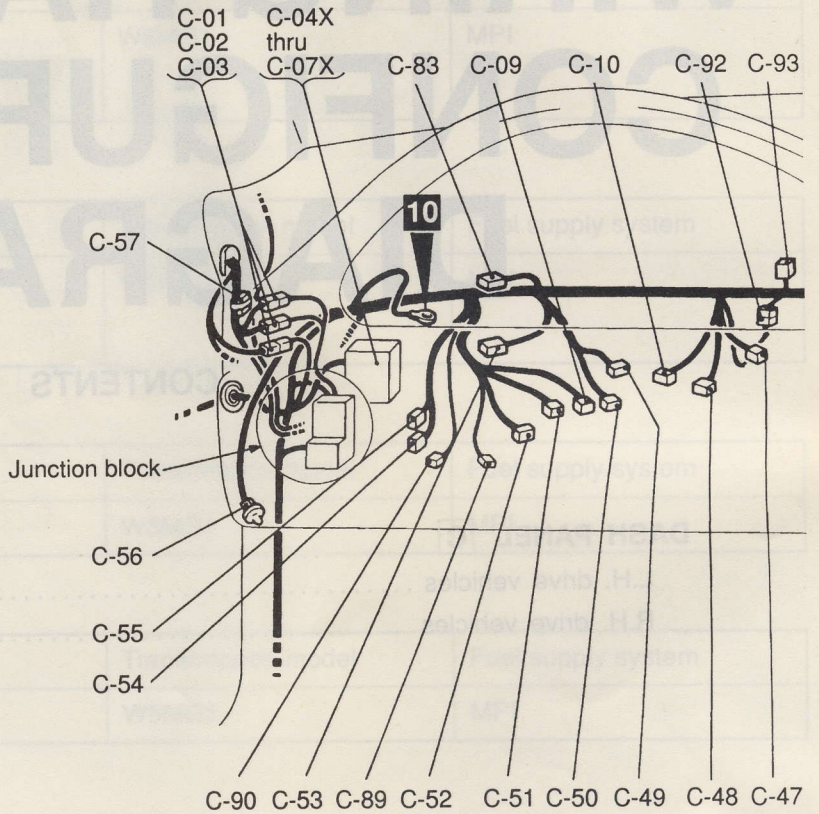

- C-23 } Body wiring harness (main) and front wiring harness combination
- C-24 }
- C-25 } Body wiring harness (sub) and front wiring harness combination
- C-26 }
- C-27 Body wiring harness (main) and body wiring harness (sub) combination
- C-28 Foot lamp (RH)
- C-29 Body wiring harness (sub) and control wiring harness combination
- C-30 Auto-cruise control unit
- C-31 Blower motor
- C-32 } -
- C-33 }
- C-34 Air-thermo sensor
- C-35 Engine coolant temperature sensor
- C-36 Engine control relay
- C-37 } -
- thru }
- C-39 }
- C-40 Lighting monitor buzzer
- C-41 Headlamp washer relay
- C-42 Engine oil level relay
- C-43 } Engine control unit
- C-44 }
- C-45 }

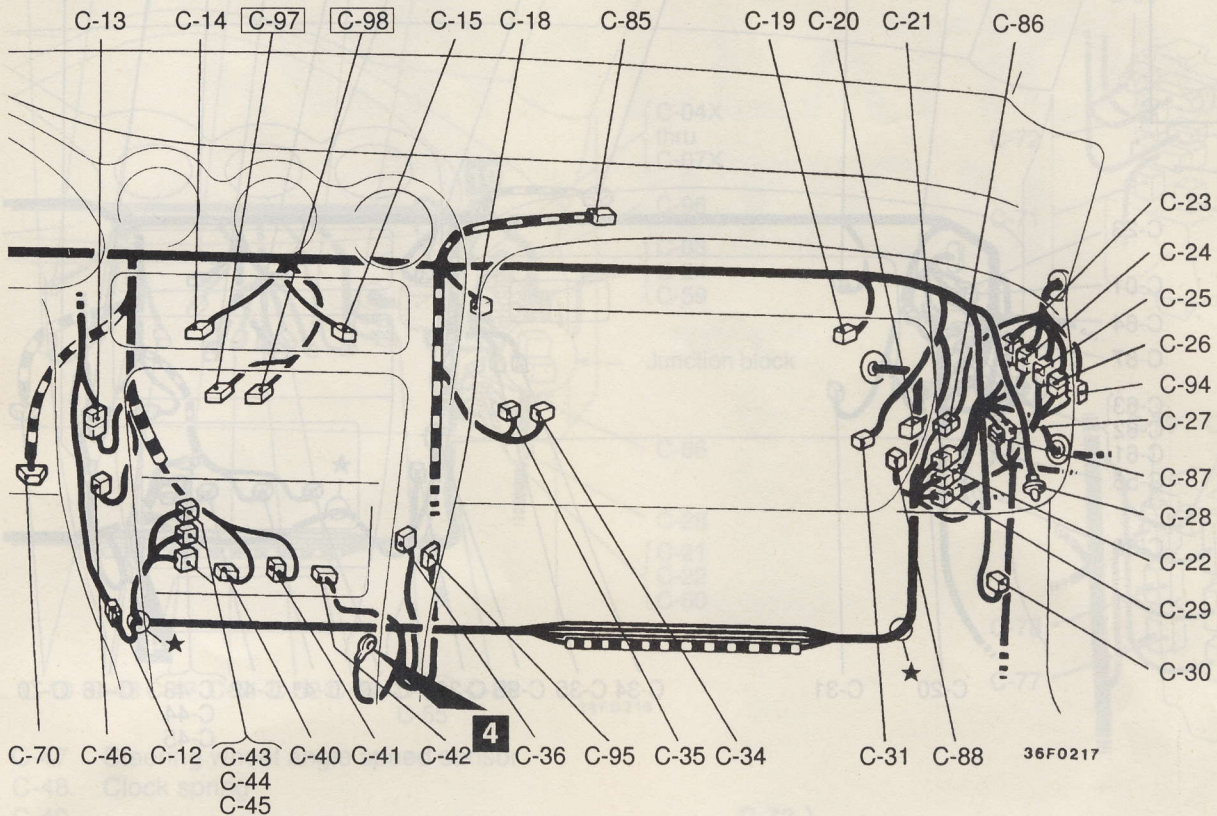

- C-46 Auto-cruise control relay
- C-47 Steering wheel angle speed sensor
- C-48 Clock spring
- C-49 No connection
- C-50 Stop lamp switch
- C-51 Key reminder switch
- C-52 Ignition switch
- C-53 Clutch pedal switch
- C-54 } ETACS control unit
- C-55 }
- C-56 Foot lamp (LH)
- C-57 Diode (for headlamp circuit)
- C-58 } -
- thru }
- C-64 }
- C-65 } Front wiring harness and junction block combina-
- C-66 } tion
- C-67 }
- C-68 Instrument panel adapter wiring harness and junction block combination
- C-69 Theft-alarm horn relay
- C-70 Diagnosis connector
- C-71 Blower motor relay
- C-72 Roof wiring harness and junction block combina-
- tion

- C-73 } Body wiring harness (main) and junction block
- thru } combination
- C-79 }
- C-80 }
- C-81 } -
- C-82 }
- C-83 No connection
- C-84 -
- C-85 Air bag module (Passenger's side)
- C-86 Front wiring harness and control wiring harness combination
- C-87 Body wiring harness (main) and body wiring harness (sub) combination
- C-88 No connection
- C-89 Key ring antenna
- C-90 Immobilizer control unit
- C-92 Clock spring
- C-93 Air bag module (Driver's side)
- C-94 Body wiring harness (sub) and front wiring harness combination
- C-95 Engine control relay
- C-97 } A/C-ECU
- C-98 }

Remark
 Connector numbers enclosed by a frame are newly added connectors.

DASH PANEL

R.H. drive vehicles

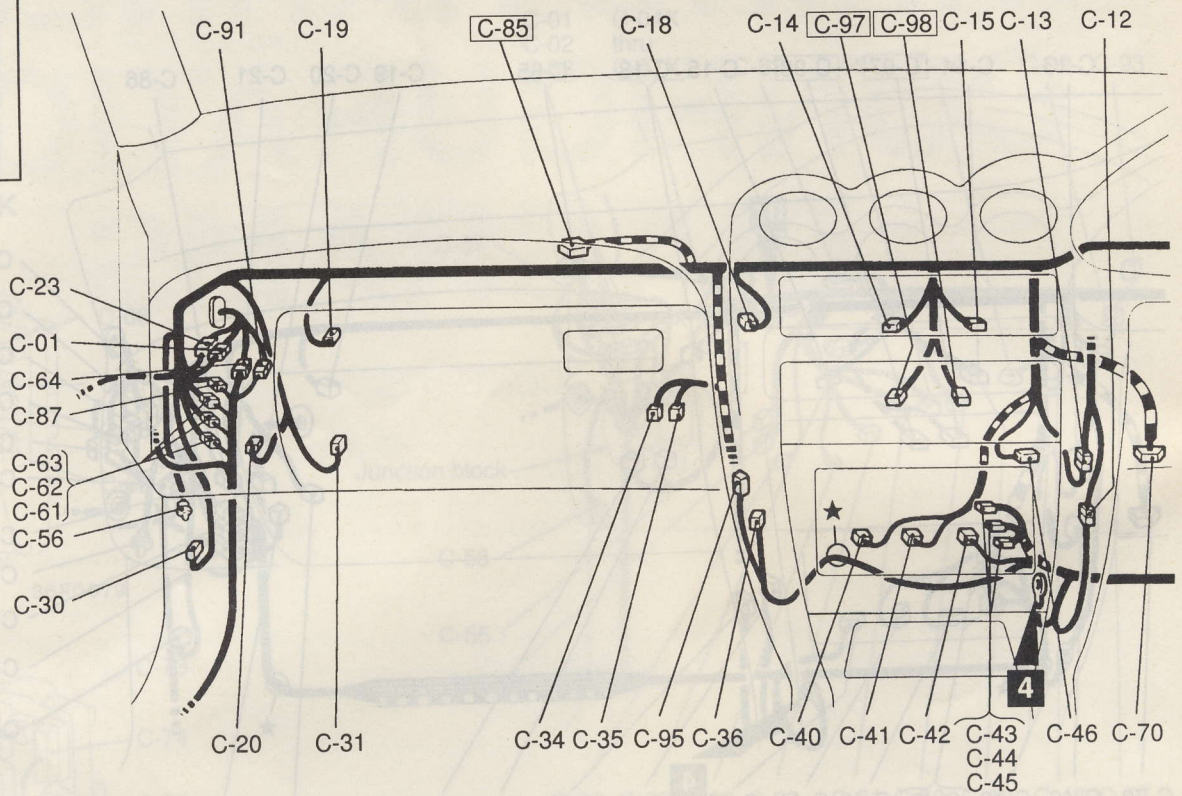
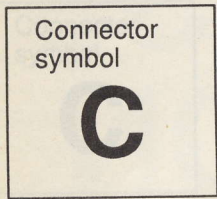

- C-01 Body wiring harness (main) and front wiring harness combination
- C-02 -
- C-03 Body wiring harness (main) and front wiring harness combination
- C-04X Door lock power relay
- C-05X Rear fog lamp relay
- C-06X Defogger relay
- C-07X Power window relay
- C-08 -
- C-09 } Column switch
- C-10 }
- C-11 -
- C-12 Control wiring harness and instrument panel wiring harness combination
- C-13 Body wiring harness (main) and instrument panel wiring harness combination
- C-14 Blend air damper control motor
- C-15 Mode selection damper control motor
- C-16 } -
- C-17 }
- C-18 Power transistor (for A/C circuit)
- C-19 Air-inlet sensor
- C-20 Air selection damper control motor
- C-21 } Body wiring harness (main) and control wiring harness combination
- C-22 }

Refer to CENTRALIZED JUNCTION

- C-23 } Body wiring harness (main) and front wiring harness combination
- C-24 }
- C-25 }
- C-26 } -
- C-27 }
- C-28 Foot lamp (RH)
- C-29 -
- C-30 Auto-cruise control unit
- C-31 Blower motor
- C-32 } -
- C-33 }
- C-34 Air-thermo sensor
- C-35 Engine coolant temperature sensor
- C-36 Engine control relay
- C-37 } -
- C-38 thru }
- C-39 }
- C-40 Lighting monitor buzzer
- C-41 Headlamp washer relay
- C-42 Engine oil level relay
- C-43 }
- C-44 } Engine control unit
- C-45 }
- C-46 Auto-cruise control relay

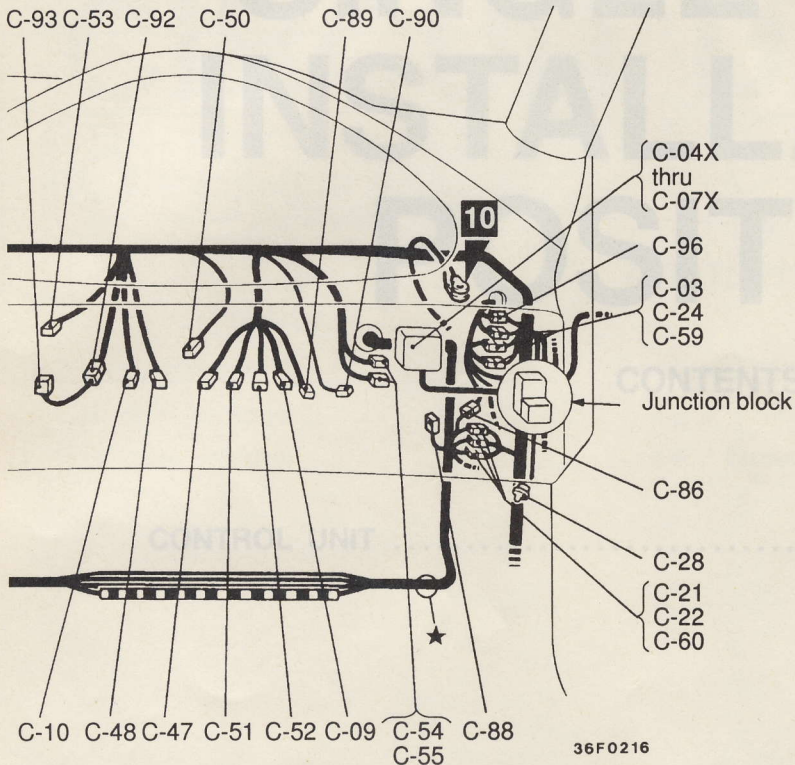

36F0216

**JUNCTION BLOCK
(Front side)**

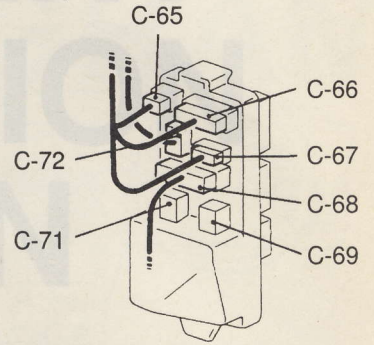

36F0079

(Rear side)

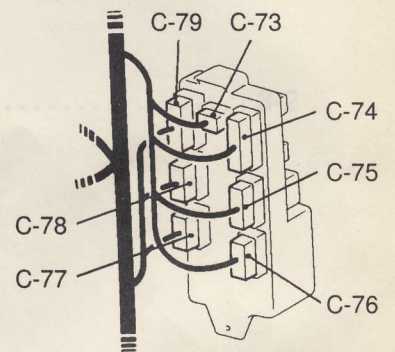

36F0140

- C-47 Steering wheel angle speed sensor
- C-48 Clock spring
- C-49 -
- C-50 Stop lamp switch
- C-51 Key reminder switch
- C-52 Ignition switch
- C-53 Clutch pedal switch
- C-54 } ETACS control unit
- C-55 }
- C-56 Foot lamp (LH)
- C-57 } -
- C-58 }
- C-59 Body wiring harness (main) and front wiring harness combination
- C-60 Body wiring harness (main) and control wiring harness combination
- C-61 } Body wiring harness (main) and body wiring harness (sub) combination
- C-62 }
- C-63 }
- C-64 Body wiring harness (sub) and front wiring harness combination
- C-65 } Front wiring harness and junction block combination
- C-66 }
- C-67 }
- C-68 Instrument panel adapter wiring harness and junction block combination
- C-69 Theft-alarm horn relay
- C-70 Diagnosis connector
- C-71 Blower motor relay
- C-72 Roof wiring harness and junction block combination

- C-73 } Body wiring harness (main) and junction block combination
- C-79 }
- C-80 } -
- C-84 }
- C-85 } Air bag module (Passenger's side)
- C-86 } Front wiring harness and control wiring harness combination
- C-87 } Body wiring harness (main) and body wiring harness (sub) combination
- C-88 } No connection
- C-89 } Key ring antenna
- C-90 } Immobilizer control unit
- C-91 } Body wiring harness (sub) and front wiring harness combination <Vehicles with sunroof>
- C-92 } Clock spring
- C-93 } Air bag module (Driver's side)
- C-94 } -
- C-95 } Engine control relay
- C-96 } Body wiring harness (main) and front wiring harness combination
- C-97 } A/C-ECU
- C-98 }

Remark
Connector numbers enclosed by a frame are newly added or transferred connectors.

SINGLE PART INSTALLATION POSITION

CONTENTS

CONTROL UNIT	3-2
--------------------	-----

CONTROL UNIT

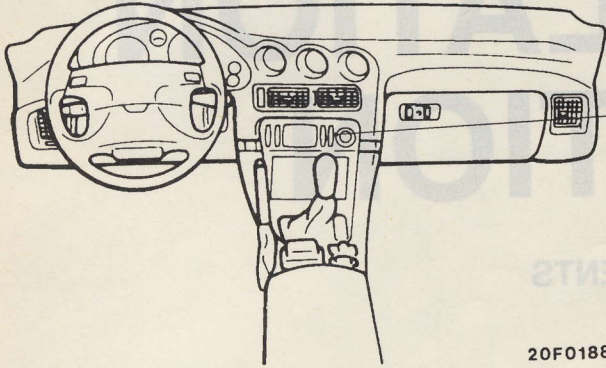

20F0188

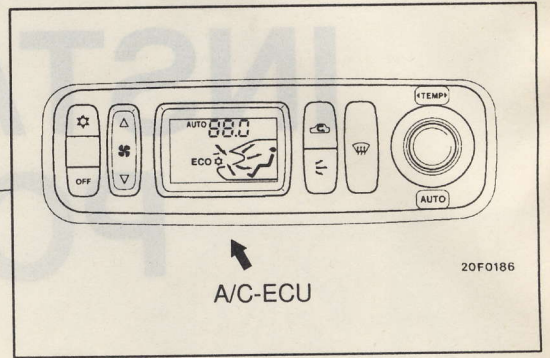

20F0186

A/C-ECU

CIRCUIT DIAGRAM

CONTENTS

AIR CONDITIONER

L.H. drive vehicles	4-2
R.H. drive vehicles	4-8

SUPPLEMENTAL RESTRAINT SYSTEM

<SRS>	4-14
-------------	------

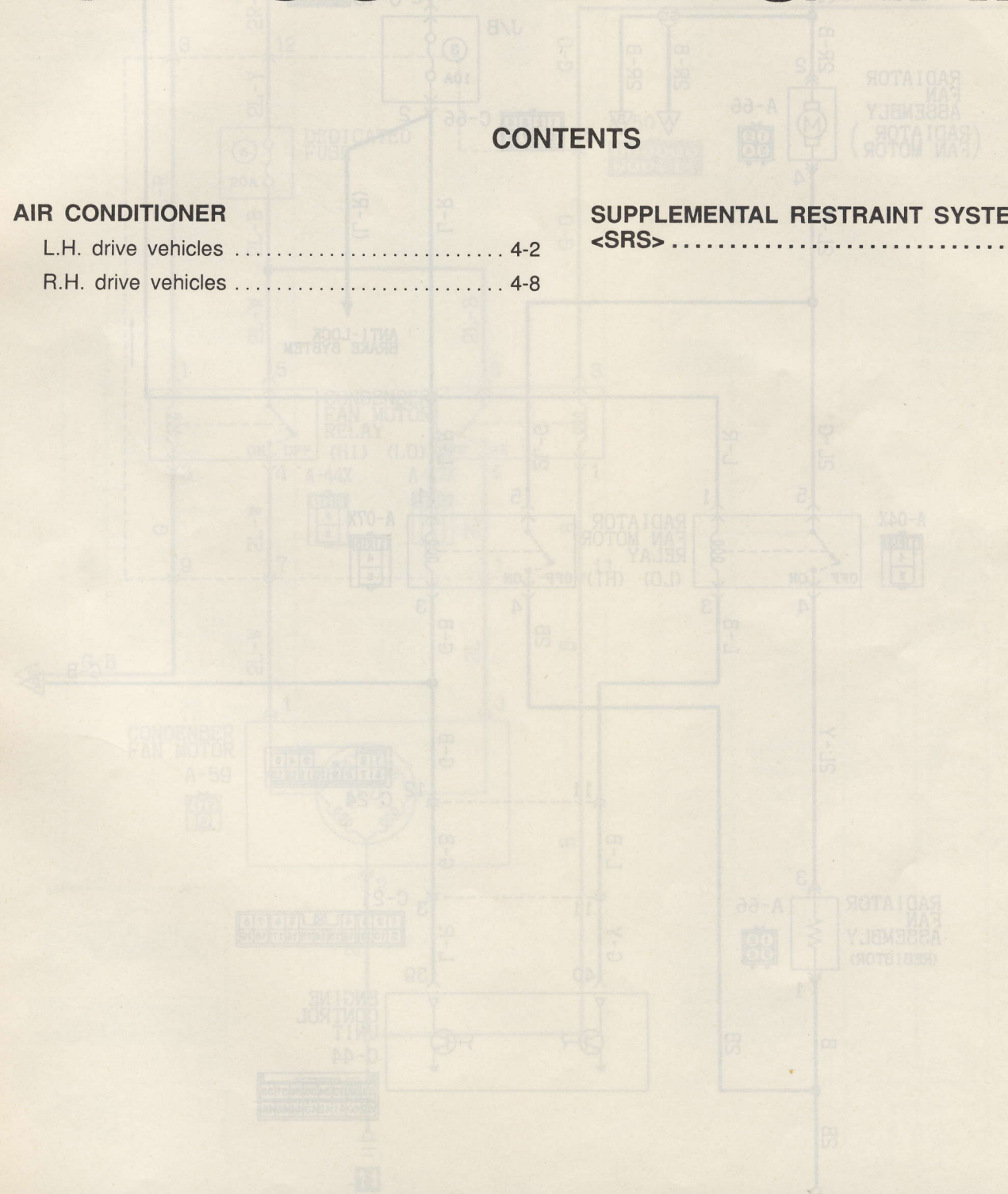

AIR CONDITIONER

L.H. drive vehicles

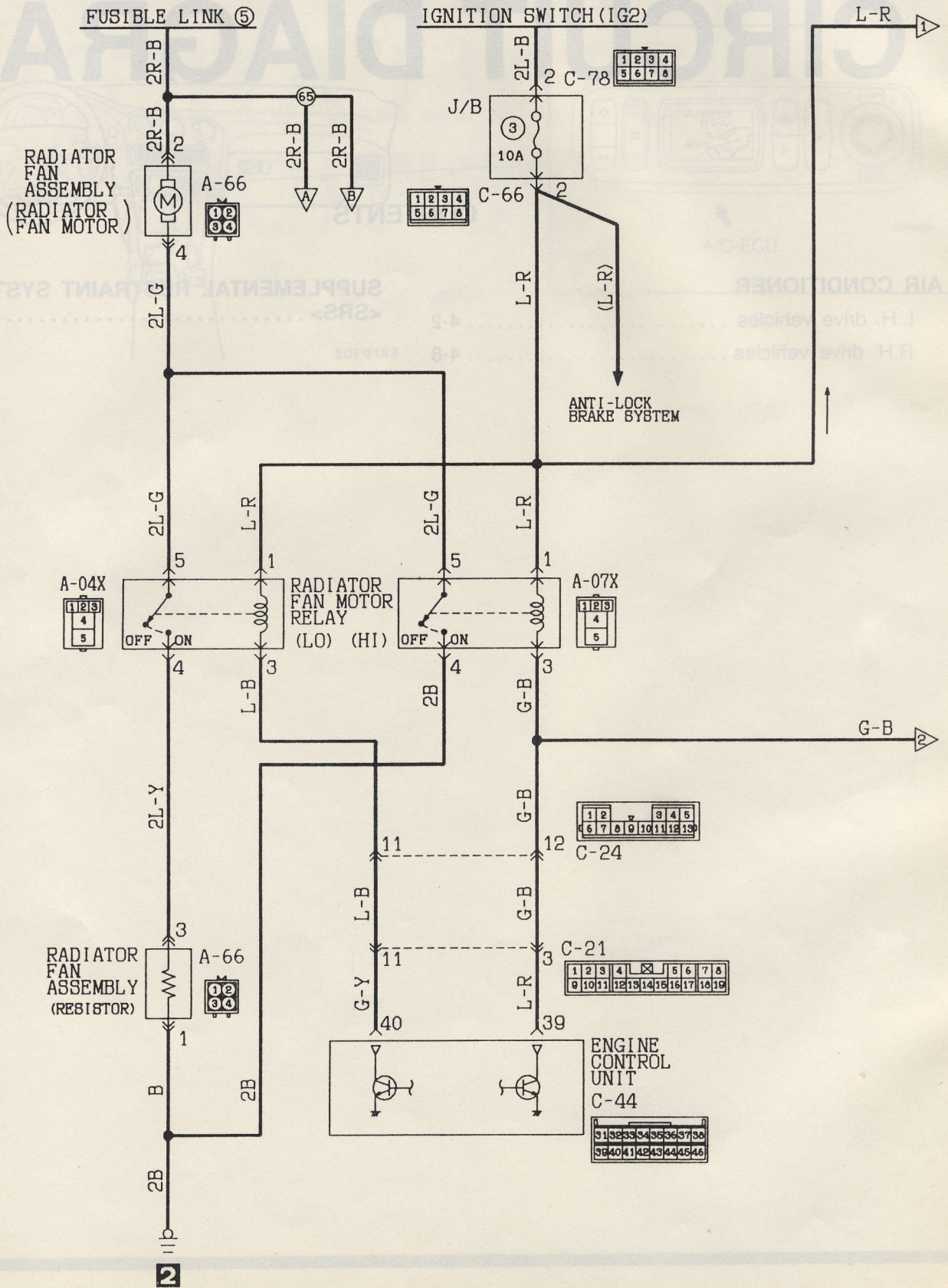

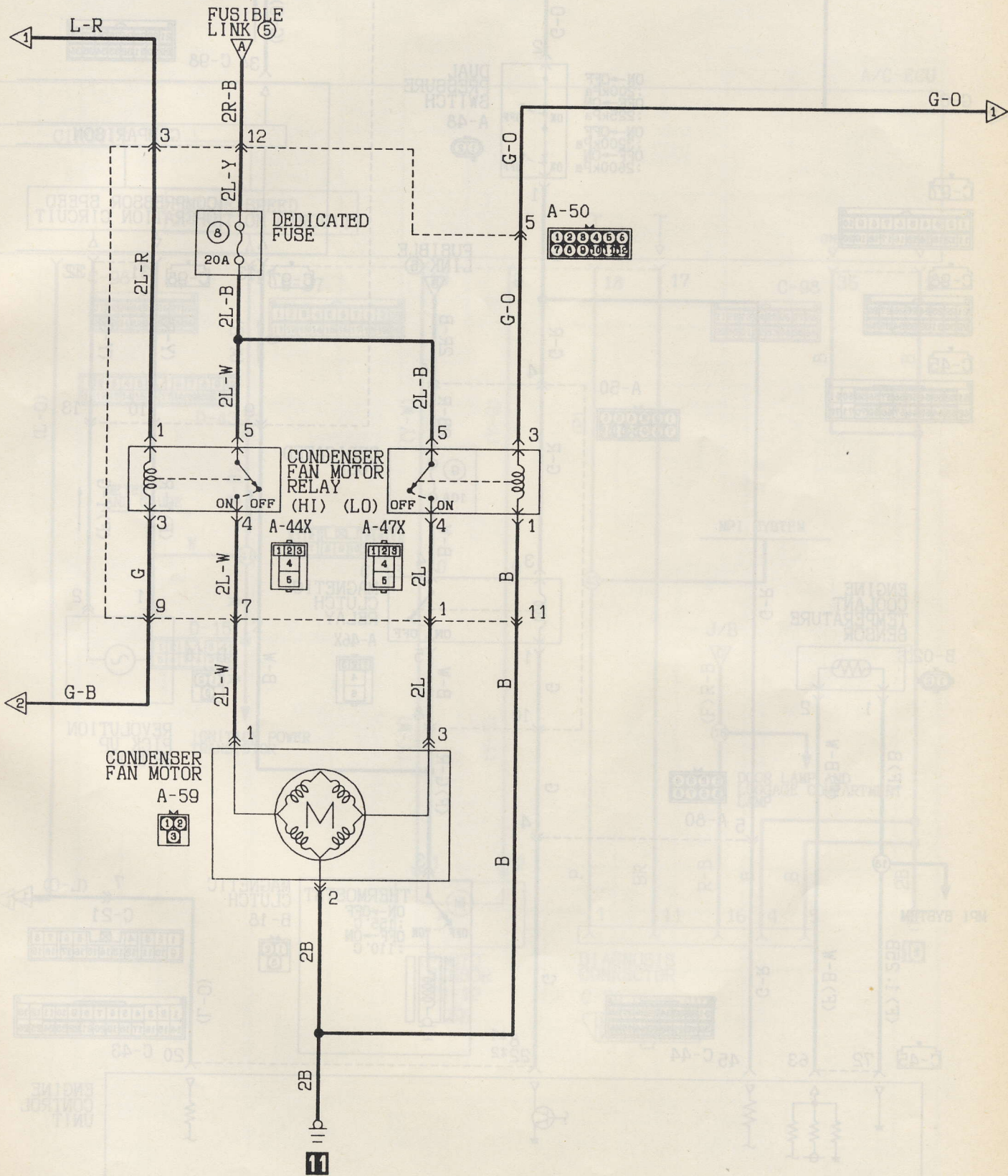

Wire color code

B :Black LG :Light green G :Green L :Blue W :White Y :Yellow SB :Sky blue
 BR :Brown O :Orange GR :Gray R :Red P :Pink V :Violet

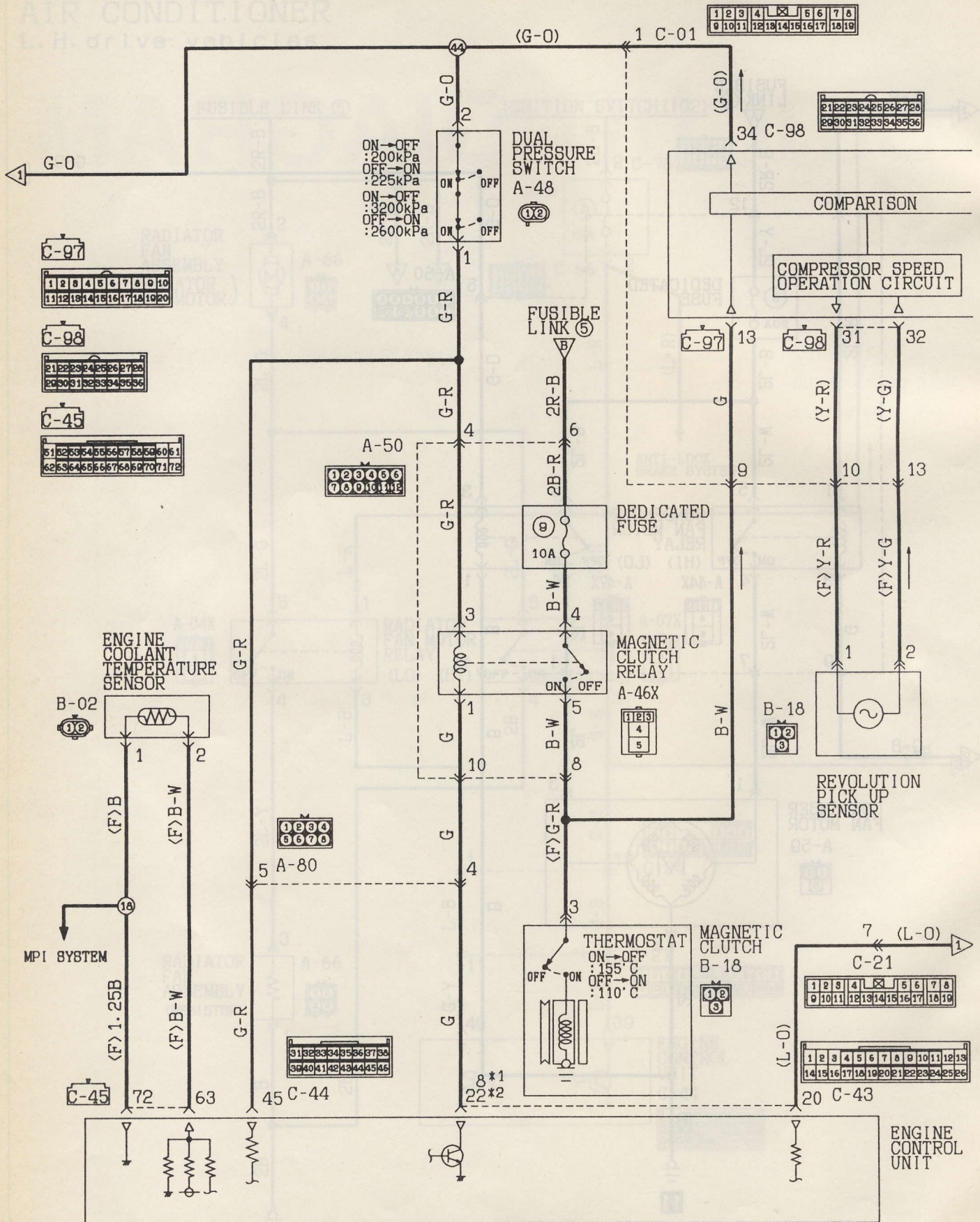

Remarks
 *1: Vehicles without Immobilizer system
 *2: Vehicles with Immobilizer system

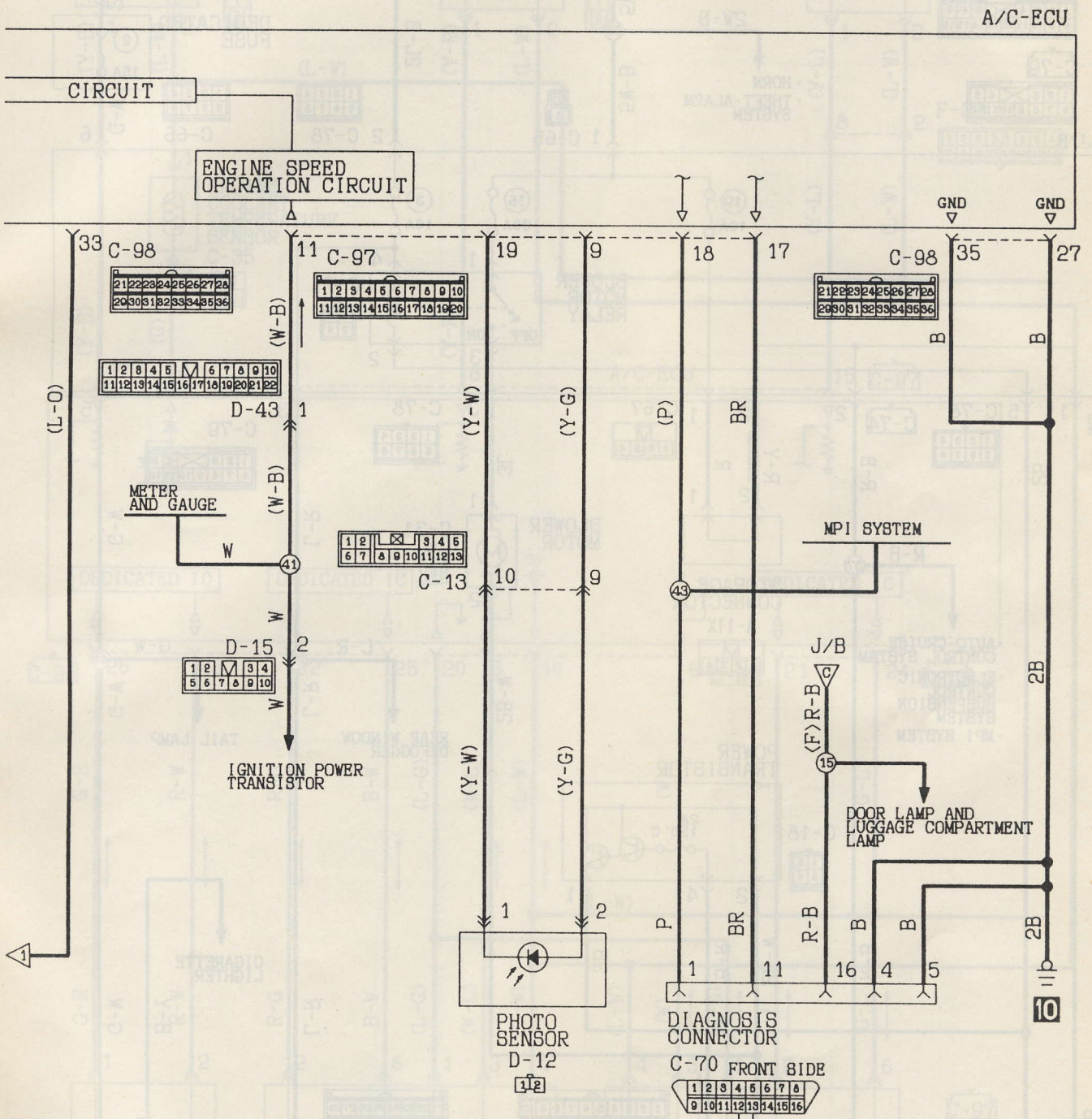

Wire color code

B :Black LG :Light green G :Green L :Blue W :White Y :Yellow SB :Sky blue
 BR :Brown O :Orange GR :Gray R :Red P :Pink V :Violet

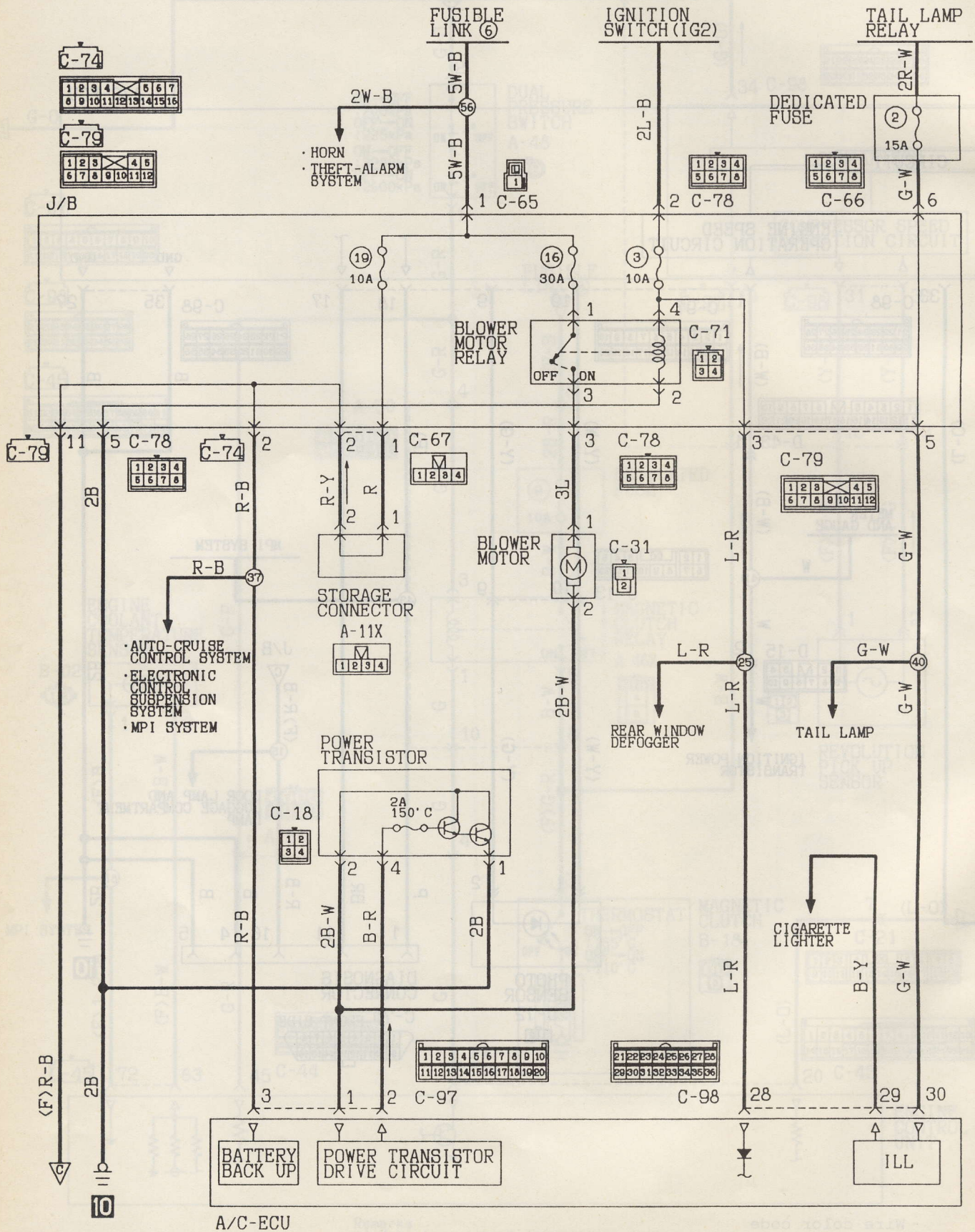

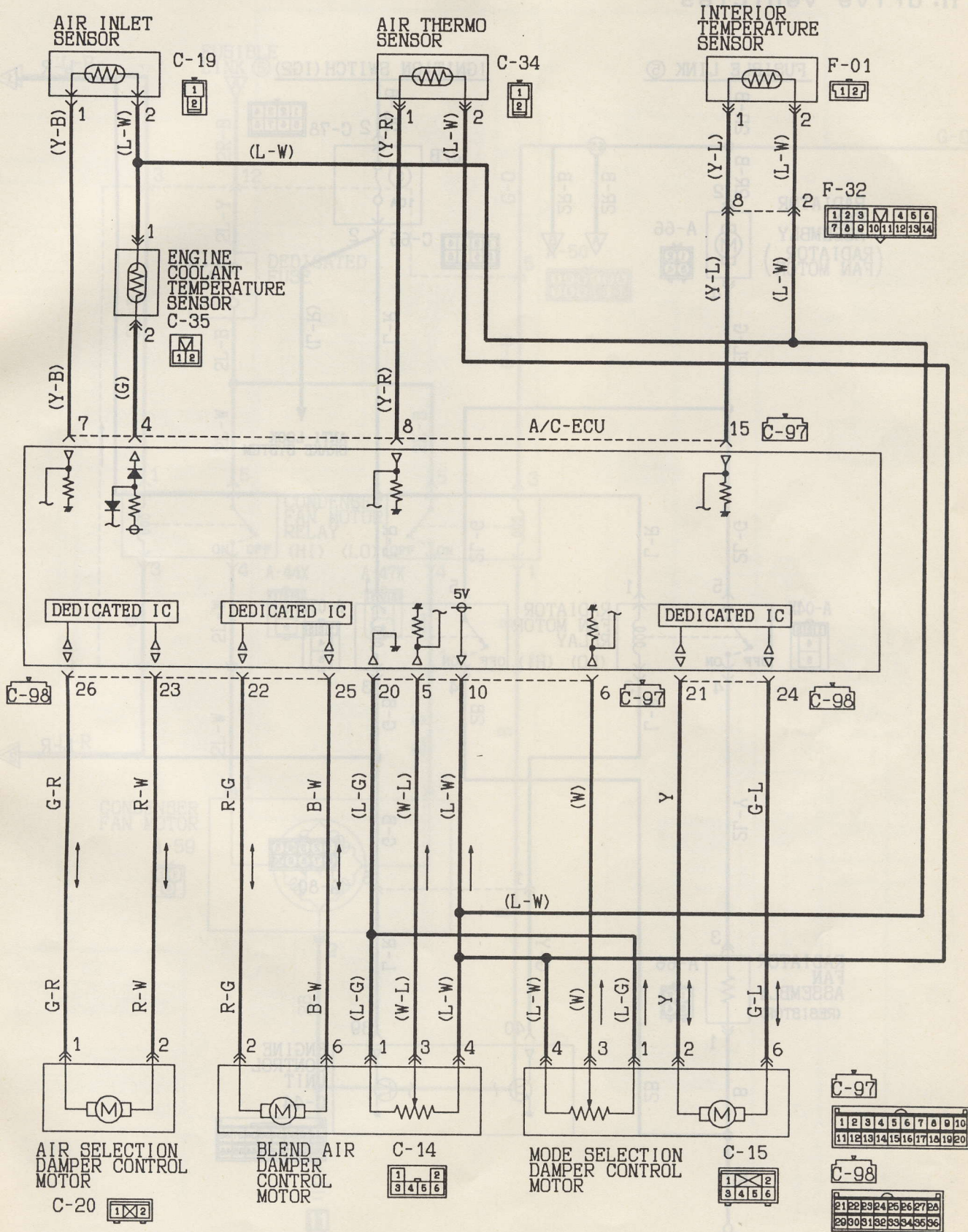

Wire color code

B :Black LG :Light green G :Green L :Blue W :White Y :Yellow SB :Sky blue
 BR :Brown O :Orange GR :Gray R :Red P :Pink V :Violet

AIR CONDITIONER

R. H. drive vehicles

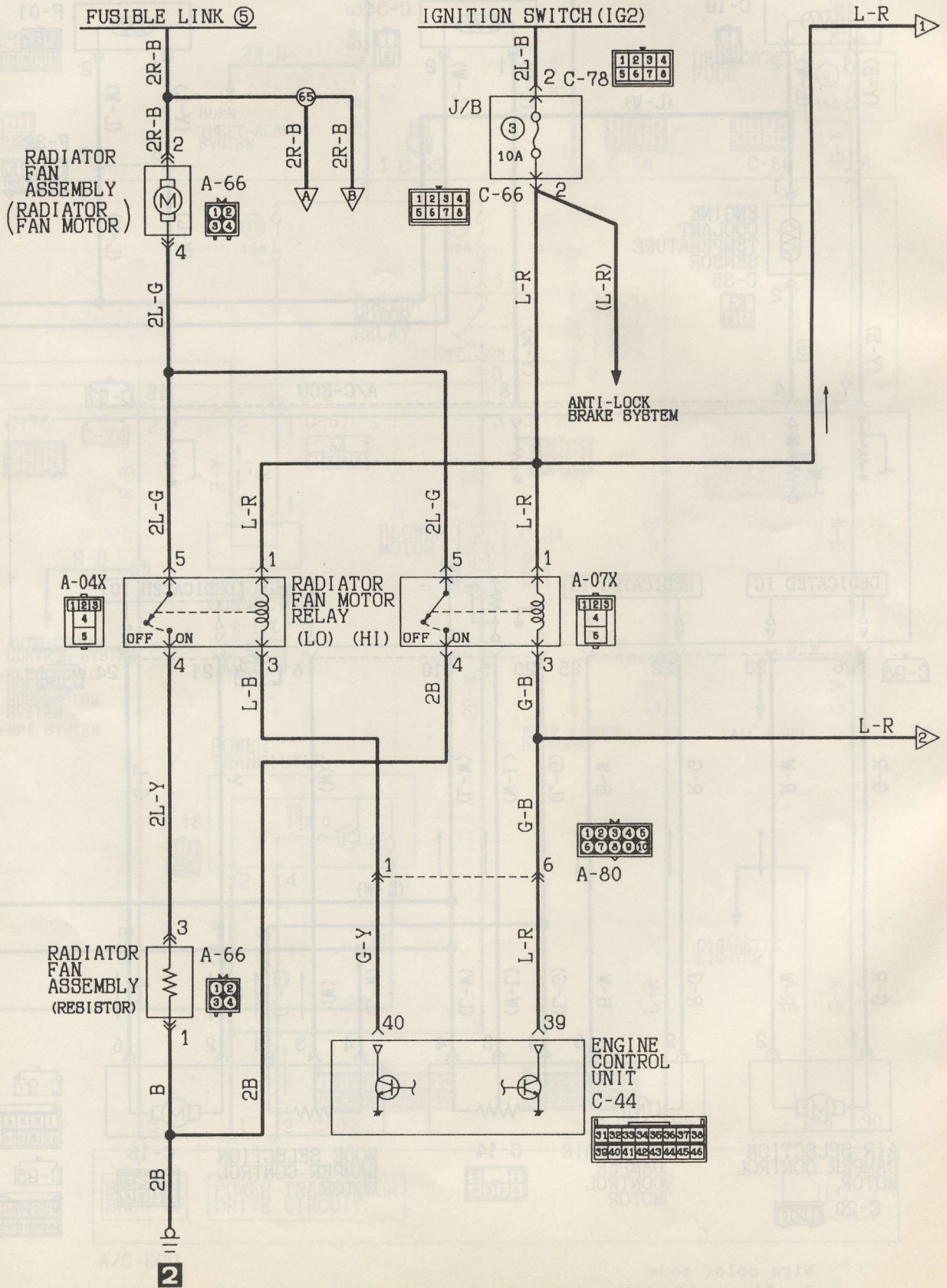

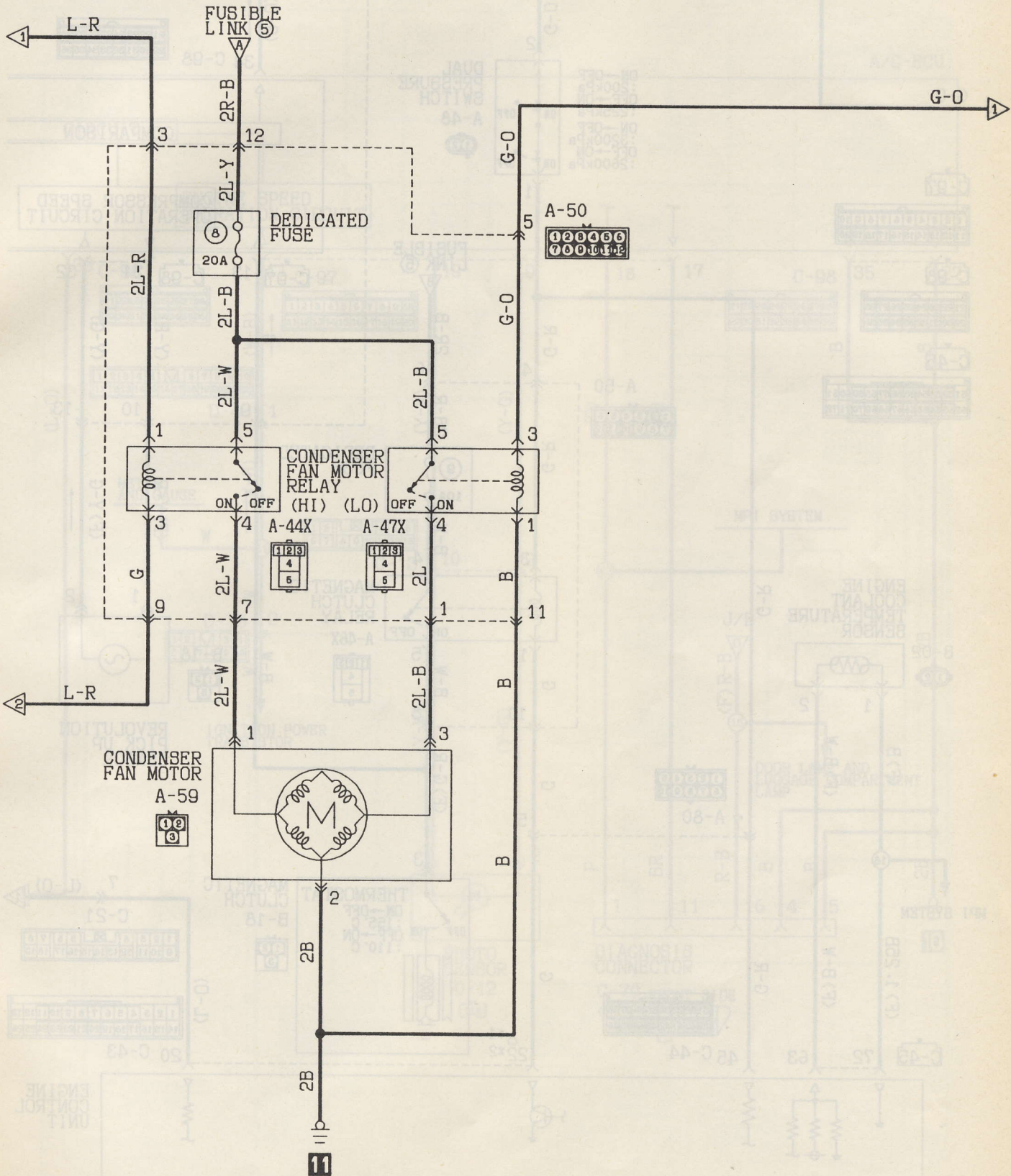

Wire color code

B :Black LG:Light green G :Green L :Blue W :White Y :Yellow SB :Sky blue
 BR :Brown O :Orange GR :Gray R :Red P :Pink V :Violet

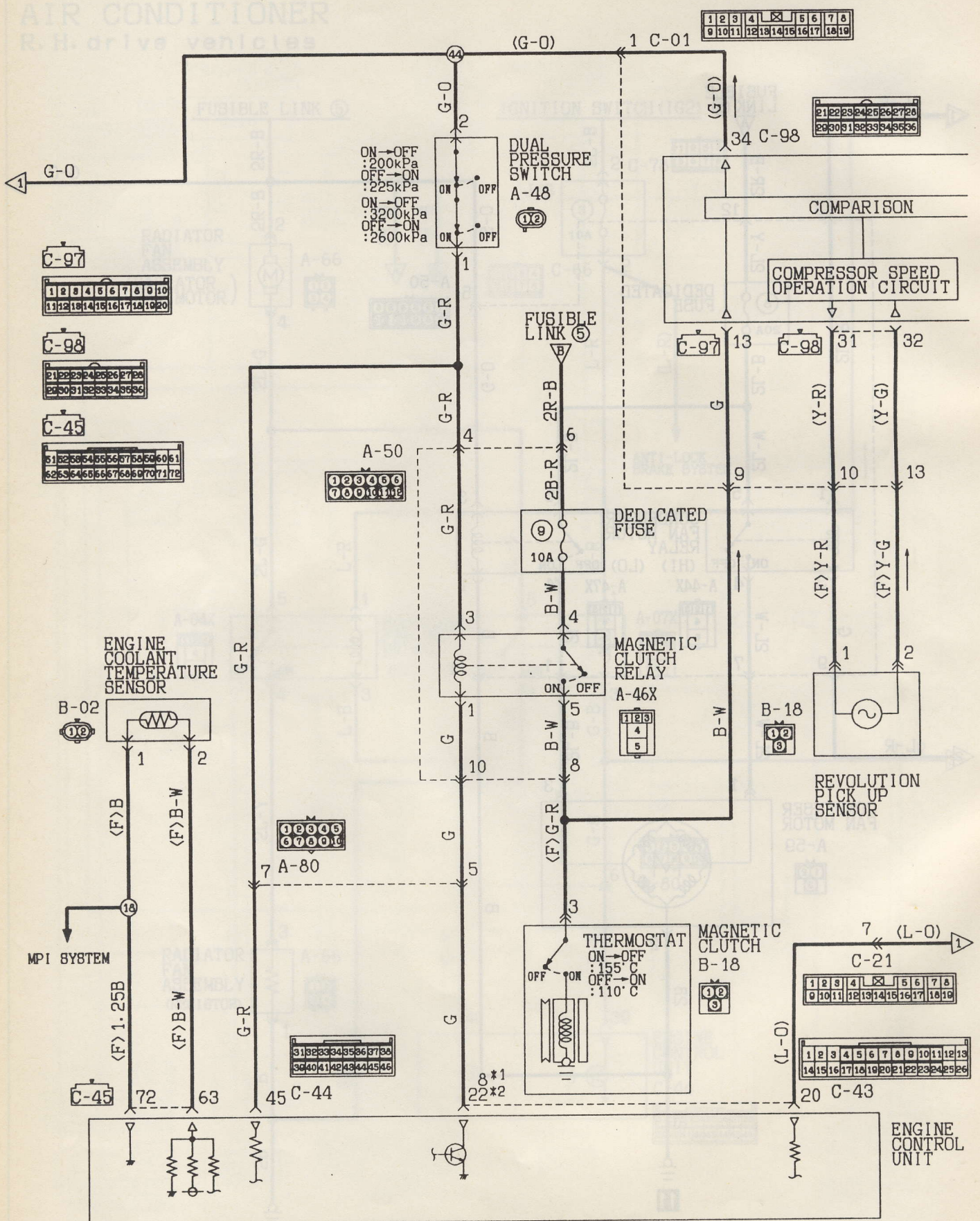

A/C-ECU

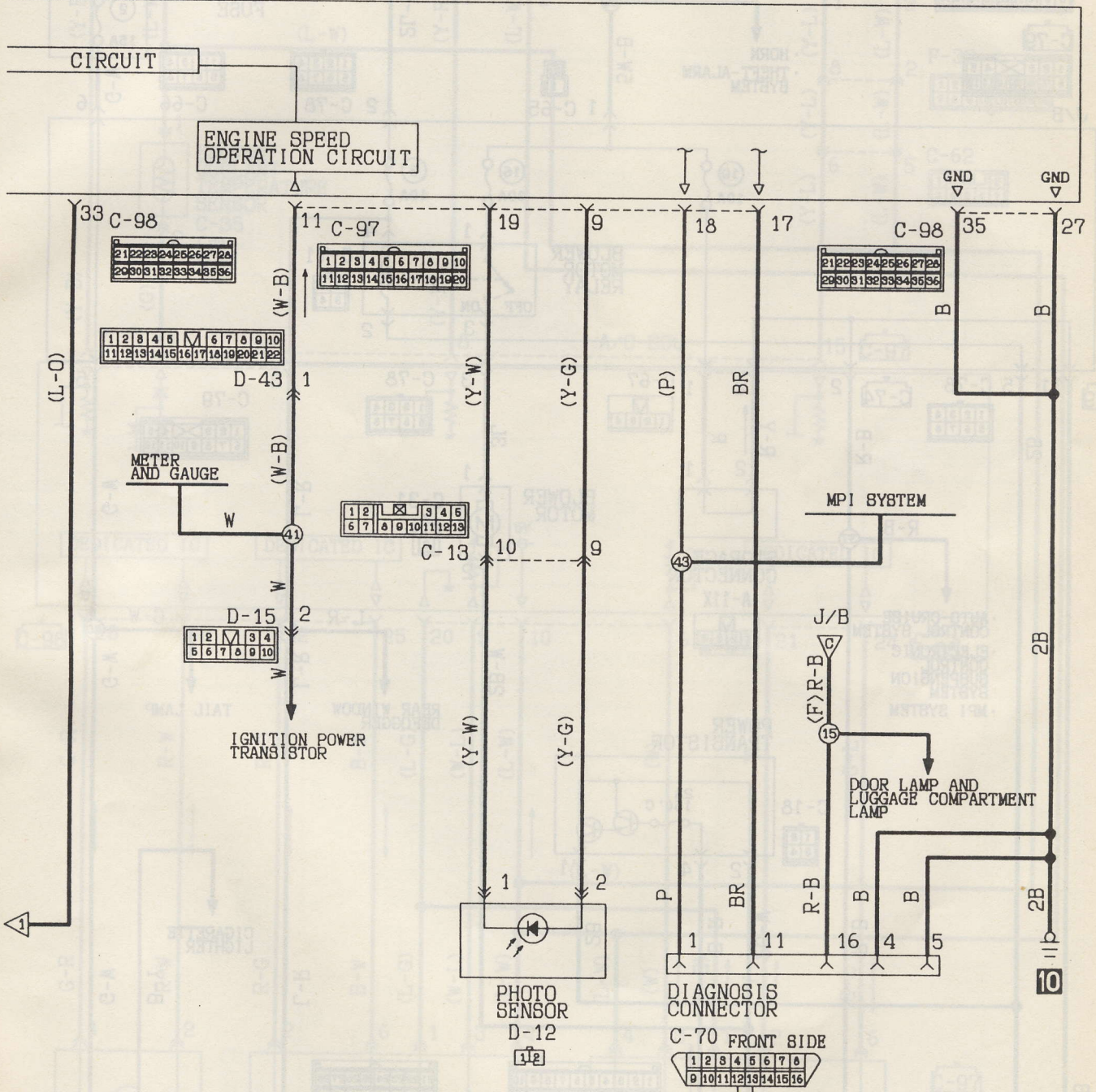

Wire color code

B :Black LG :Light green G :Green L :Blue W :White Y :Yellow SB :Sky blue
 BR :Brown O :Orange GR :Gray R :Red P :Pink V :Violet

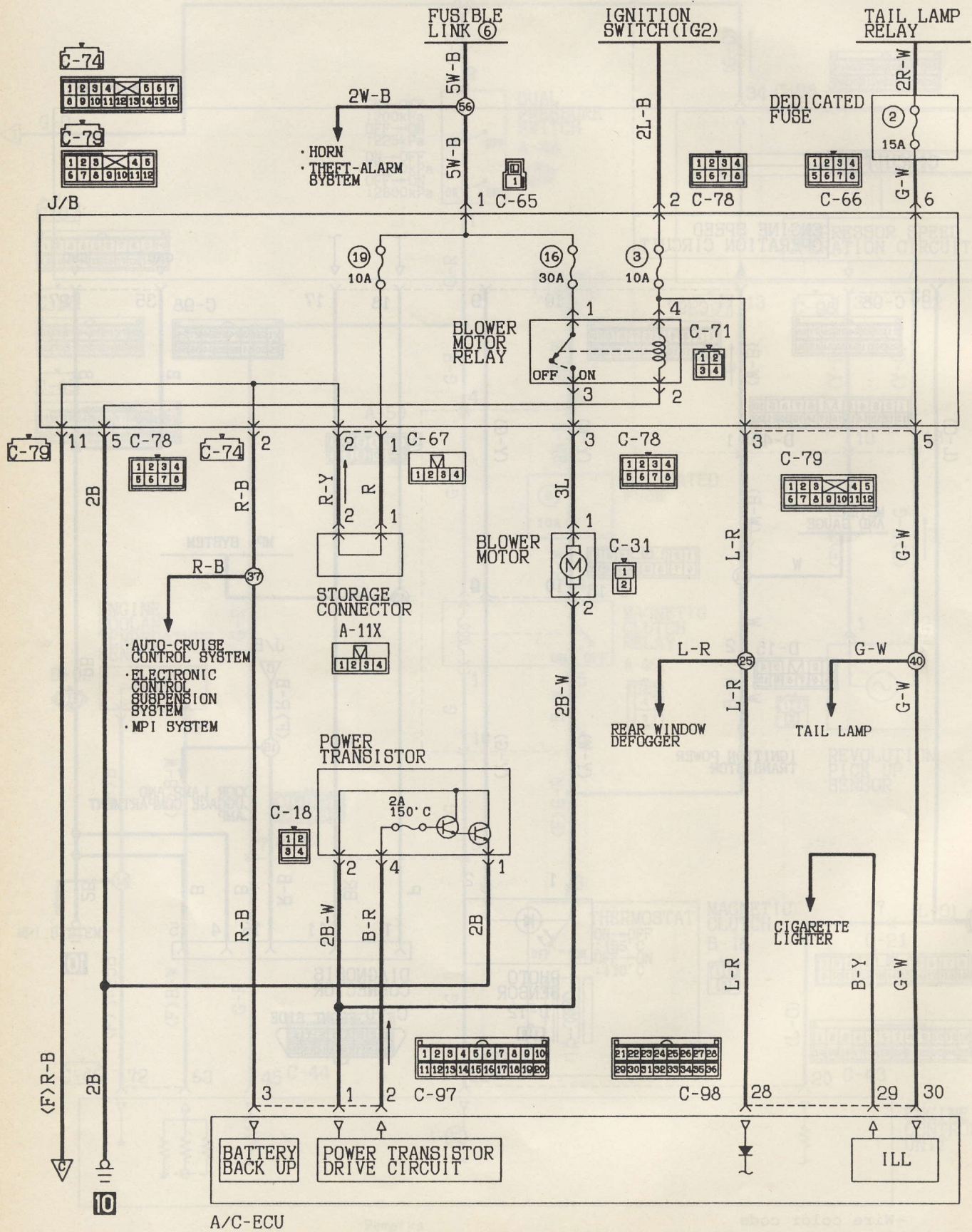

A/C-ECU

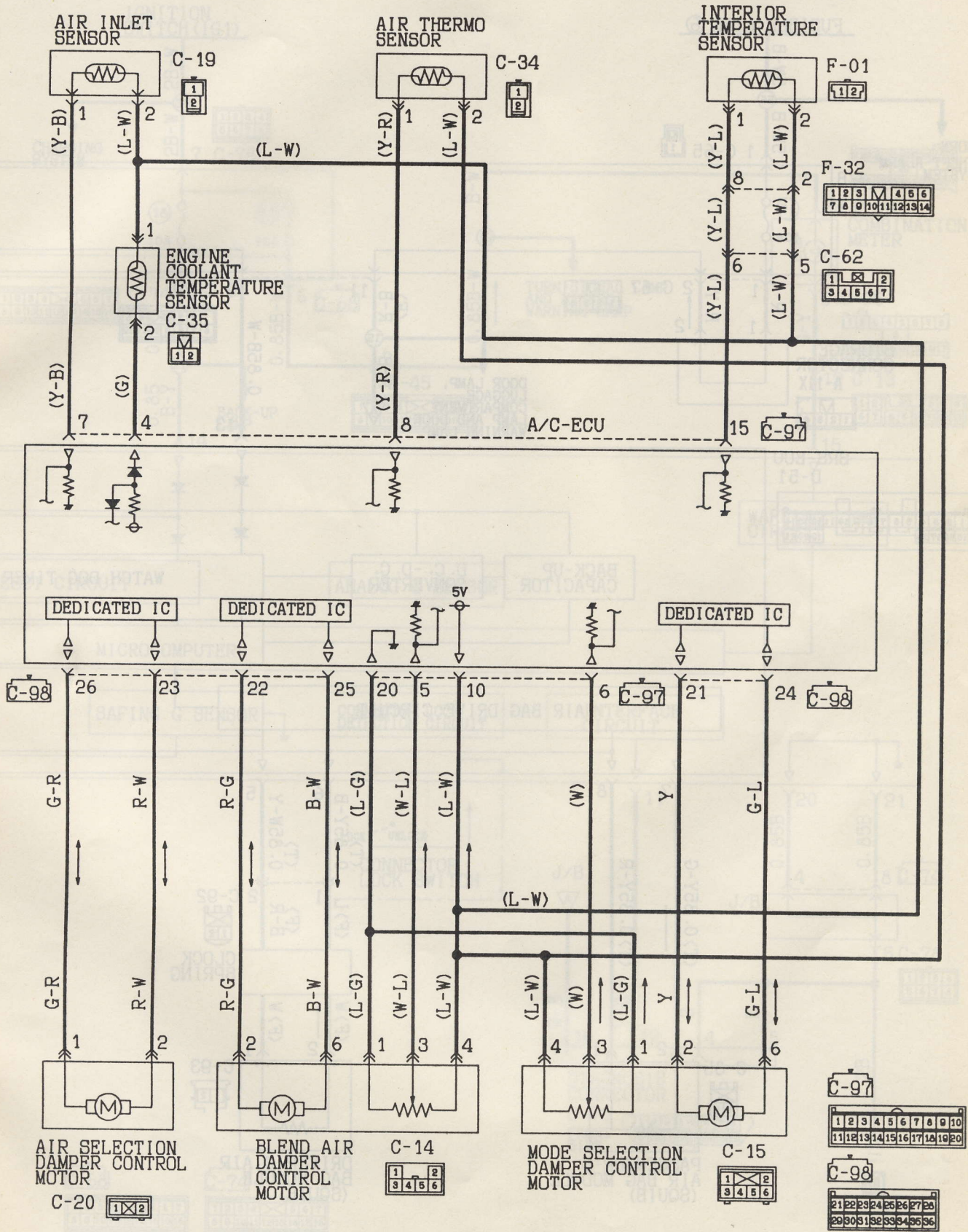

Wire color code

B :Black LG :Light green G :Green L :Blue W :White Y :Yellow SB :Sky blue
BR :Brown O :Orange GR :Gray R :Red P :Pink V :Violet

SUPPLEMENTAL RESTRAINT SYSTEM (SRS)

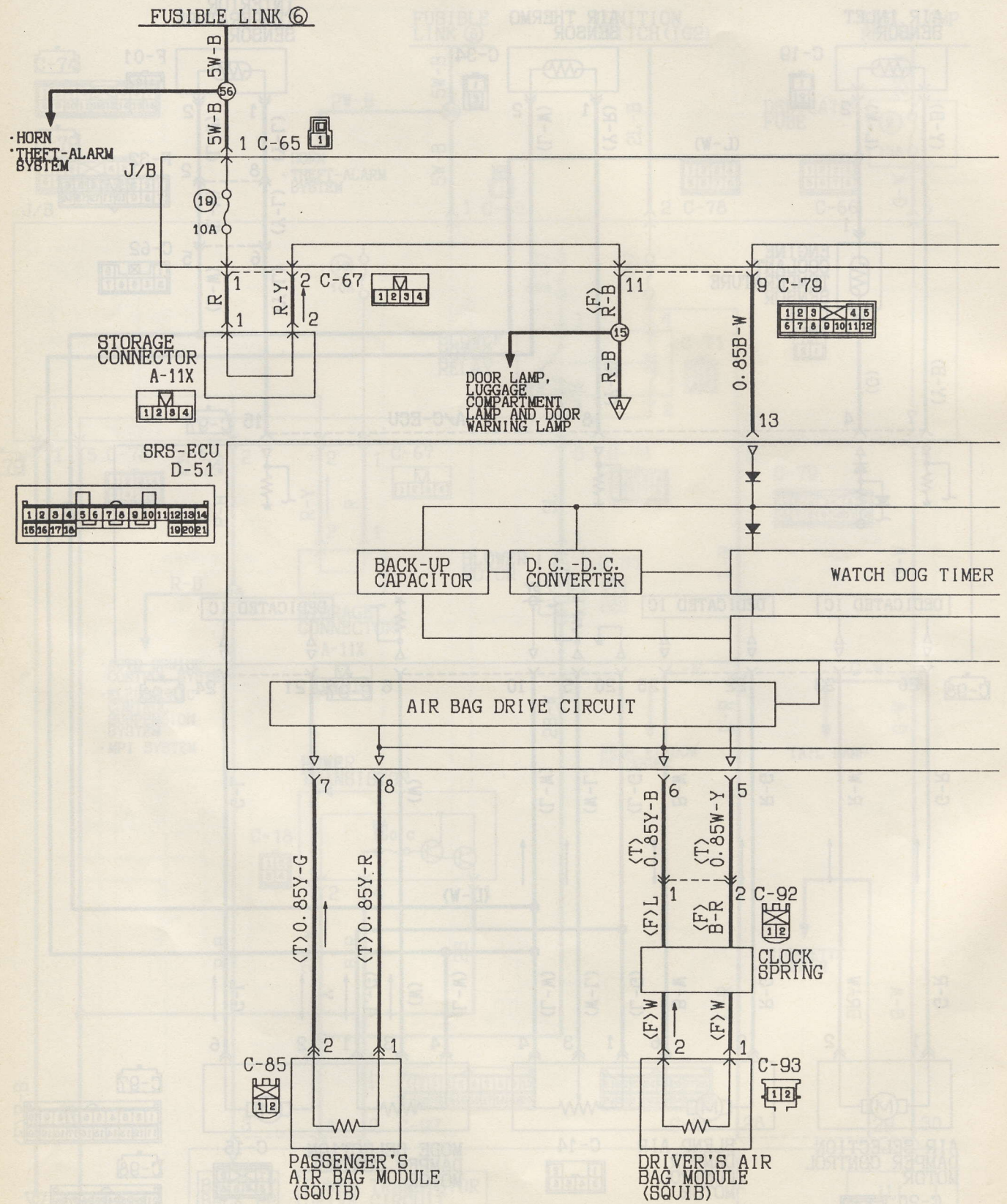

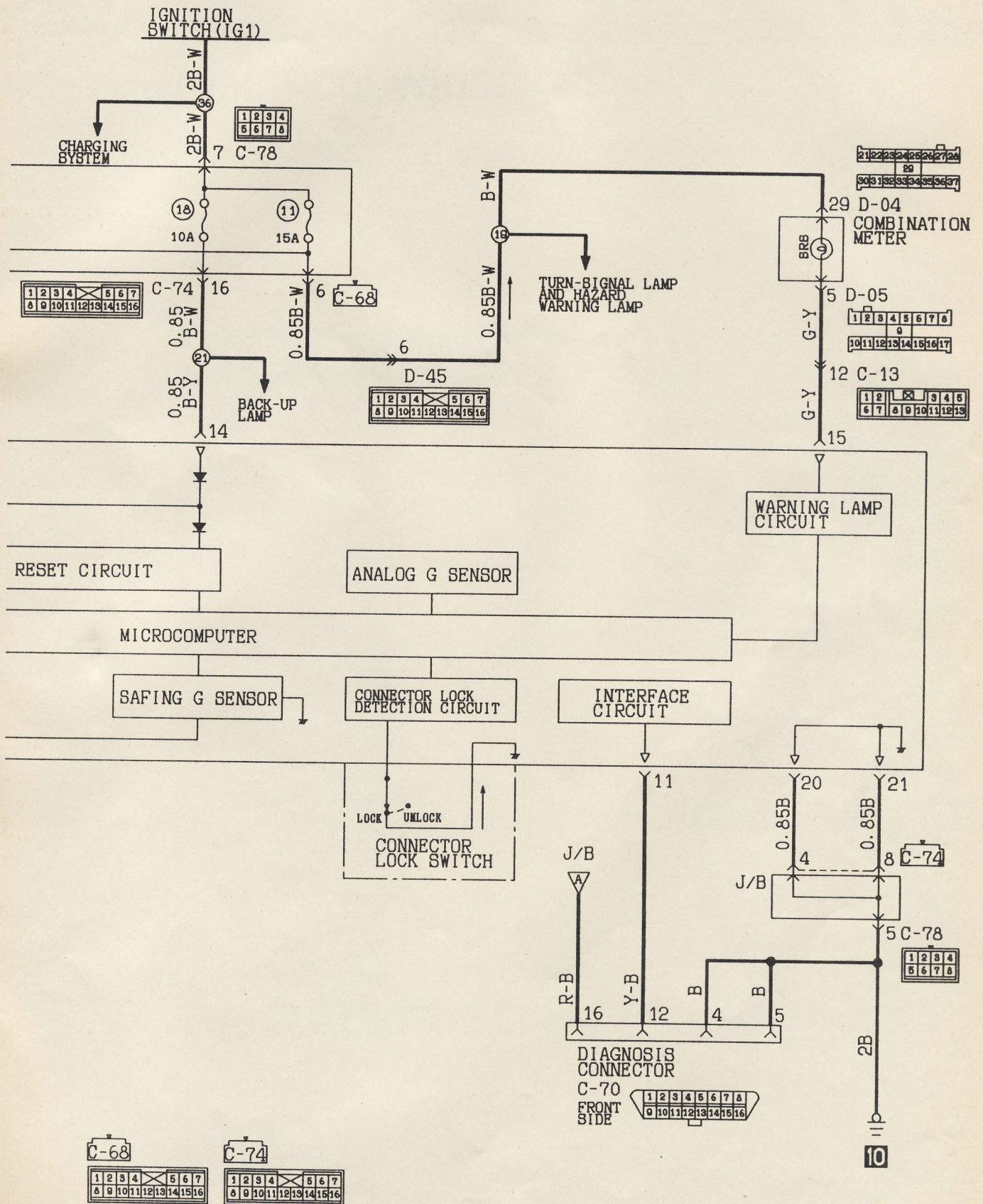

Wire color code
 B :Black LG :Light green G :Green L :Blue W :White Y :Yellow SB :Sky blue
 BR :Brown O :Orange GR :Gray R :Red P :Pink V :Violet